

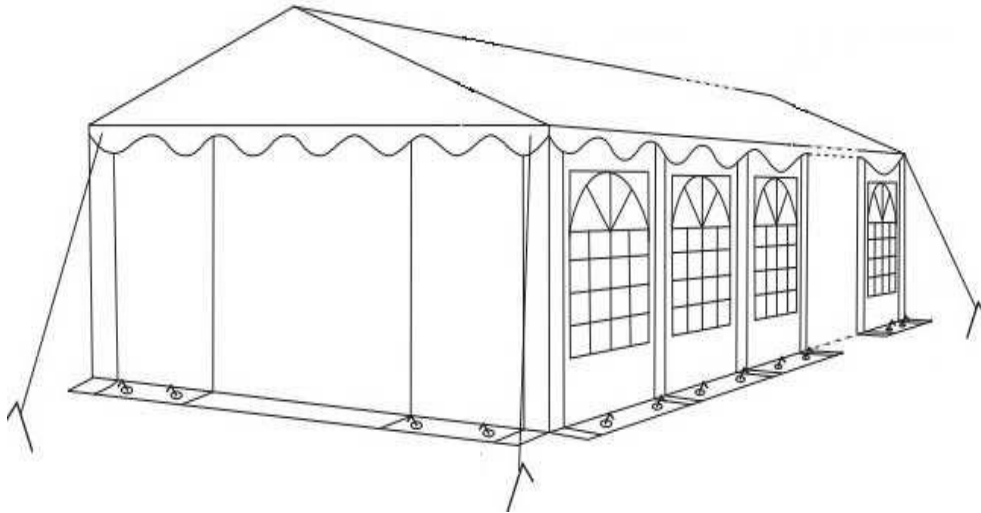

4m - series ★★★★★ Professional Prime

Party Tent



This high-quality tent is flame retardant and therefore can be used for public events. PVC cover according:

	FIRE RESISTANT
	IGNIFUG
	FEUERSICHER
	EN – 13501-1
MULTINATIONAL ACCEPTANCE	
RO, BG, HU, GR, SRB, MD, D, A, F, GB, IRL, I, E, PL, NL, P, B, CZ, HR, DK, SE, SK, FIN, LT, LV, EST, L	
VALID REPLACEMENT	
D	DIN 4101 - B1/B2
DK, S, N	SIS 650082
I	UNI 8456
CH	BKZ 5.2
F	NF P 92 - M2

Please read instructions COMPLETELY before assembly. This tent MUST be securely anchored.

This tent is a temporary structure and should be disassembled at harsh weather conditions as stormy winds, snow fall or ice.

Warnings

Prior to installation, consult with all local municipal codes regarding installation of temporary shelters. The

4m - series ★★★★★ Professional Prime

owner of the tent has the sole responsibility to make sure that these local rules are followed and that the mounting is correct.

We are not responsible for damage to the unit or the contents from acts of nature.

It is always recommended that you secure your tent properly with storm straps and ground pegs when you put up the structure. Proper Anchoring system selection is your responsibility. Heavy duty Anchor are sold separately and are not included in this product.

Periodically check the anchors to ensure stability of shelter.

In case of extreme weather conditions, the tent cover must be removed.

Any shelter that is not anchored securely has the potential to fly away causing damage. We are not responsible for any shelter that blows away.

This canopy is intended to protect against the effects of sun, rain, light snow, etc. It is not designed to hold the loads that can accompany wind, rain, snow or ice storms. This structure is not tested for specific snow, rain and wind loads.

Do not use open fire, welding equipment or other ignition sources in the tent.

Cleaning and Storage

- A tight cover ensures longer life and performance. Always maintain a tight cover. Loose fabric can accelerate deterioration of cover fabric.

- Immediately remove any accumulated water, snow or ice from the roof structure.

- DO NOT use bleach or harsh abrasive products to clean the fabric cover. Cover is easily cleaned with mild soap and water.

Safety Instructions

Please use gloves and stable shoes when assembling the metal frame portion of this unit. The metal components may have sharp edges and be oily cause of the metal processing.

Snow must be removed from the tarpaulin in a timely manner. Temporary accommodation as tents should be taken down in adverse weather condition like heavy wind, snowfall and ice.

Ensure sufficient distance of the tarpaulin to heat sources, electrical-, gas- and other pipes (min. 1.2m). You can obtain detailed information from your responsible authority.

Pay attention to the following points when choosing a location:

The pavilion must stand on a flat, non-slip and safe place

choose a sheltered location

Avoid damage to the material, please place the pavilion so that it cannot rub or chafe on branches, parts of buildings etc.

Put up the pavilion at a safe distance to fireplaces and pay attention to the direction of the wind

Leave your pavilion to dry in an erected position before packing it away.

4m - series ★★★★★ Professional Prime

Assembly Instructions

Step1. Assembly is easiest if you layout all parts on the ground as shown below. 2 meter per section, e.g. 4x4m has 2 sections, 4x6m has 3 sections, 4x8m has 4 sections, 4x10m has 5 sections and 4x12m has 6 sections.

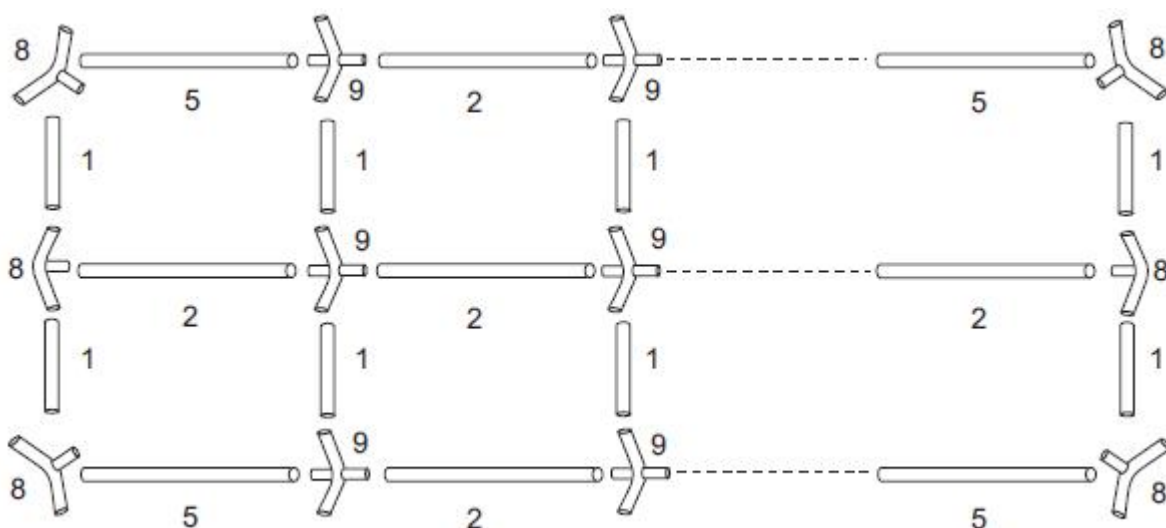

Step2. Connect the roof poles and connectors from middle and out. To ensure the bolts (18,19) fixed to every pole tightly.

Step 3: use the turnbuckle(25) and wire rope(24) to stabling the roof structure. Attach the roof braces(7) to the pipe(1) using the clamp(26).

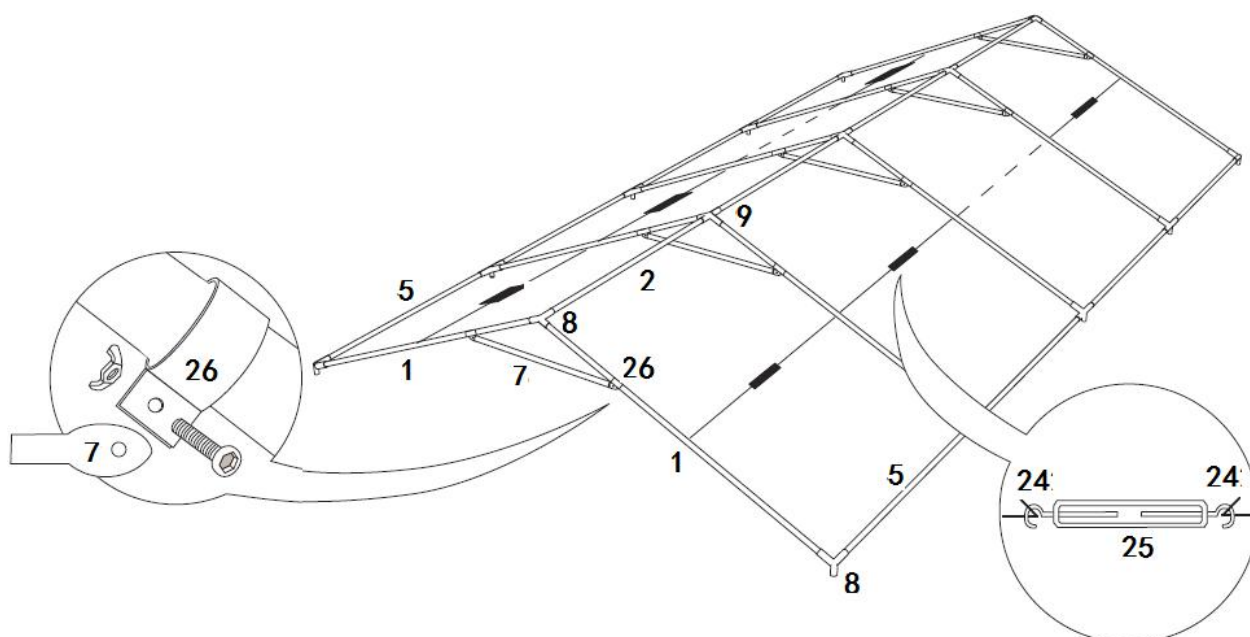

4m - series ★★★★★ Professional Prime

Step 4: Put the roof cover (28) on the frame and insert leg poles (3,4) into one side as shown below. Lift the opposite site of the frame and insert remaining leg poles to finish the tent framework.

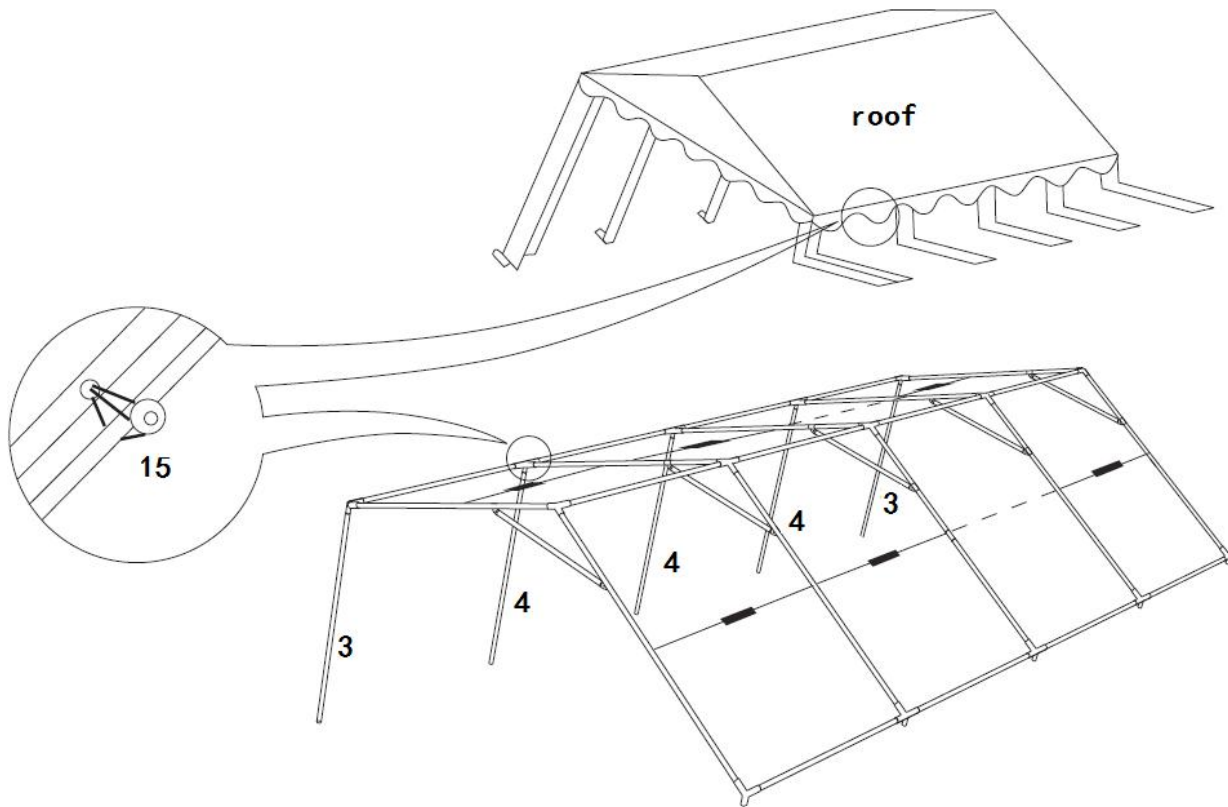

Step 5: Use the leg pegs (13) to secure the legs to the ground. Use the hooks (22) to secure the leg cover to the leg poles.

4m - series ★★★★★ Professional Prime

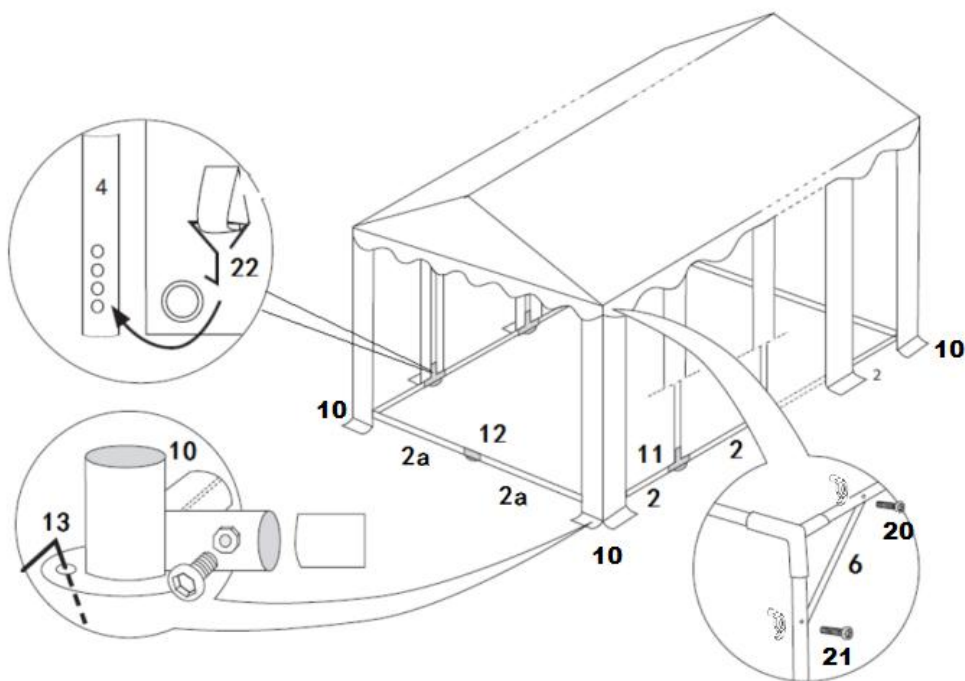

EN: Step 6: Attach side panels (29) and end panels (30) to the frame and roof with bungee balls(15,16) as shown.

Caution: Safety Goggles must be worn when secure the bungees.



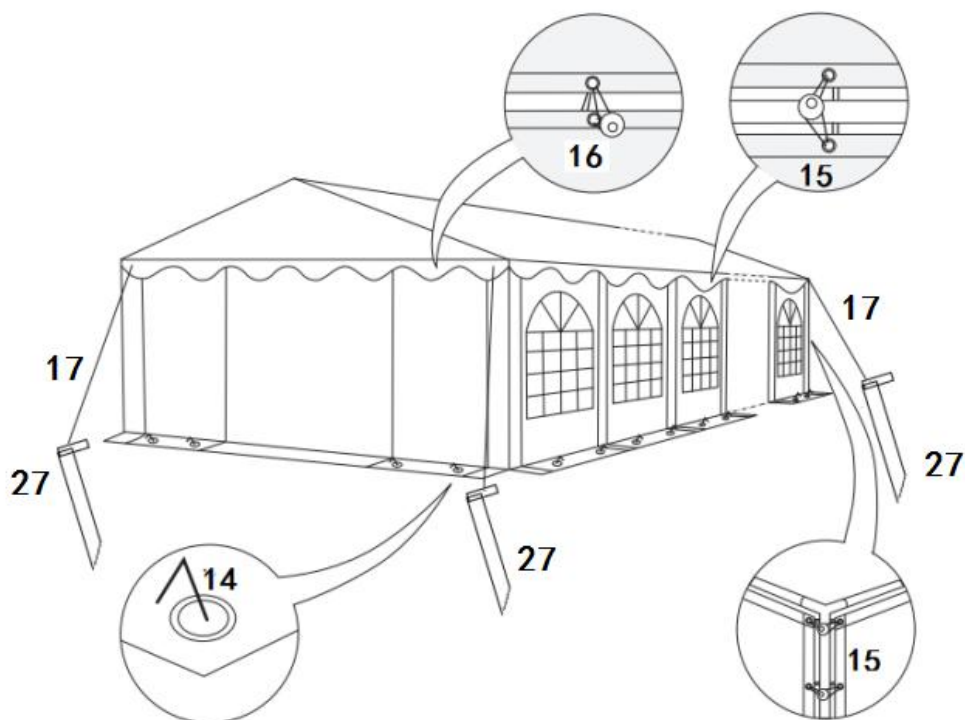





EN: Step 7: Use the thin pegs (14) to secure the side panels and end panels to the ground as show below. The guy lines (17) clasp to each corner of tent and another end of line secure to the ground by tube pegs (27).











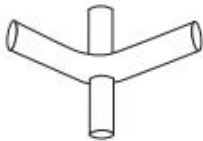
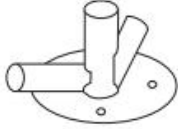
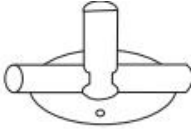
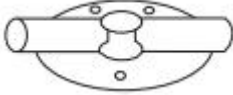

4m - series ★★★★★ Professional Prime

Parts List





Quantity

Item	Design	4x4m	4x6m	4x8m	4x10m	4x12m
No.1 Pole 50x2040mm		6	8	10	12	14
No.2 Pole 38x1920mm		6	11	16	21	26
No.2a ground bar 38x1895mm		4	4	4	4	4
No.3 leg pole 50x1888mm		4	4	4	4	4
No.4 leg pole 50x1888mm		2	4	6	8	10
No.5 pole 38x1920mm		4	4	4	4	4
No.6 brace 1174mm		4	4	4	4	4
No.7 brace 1652mm		3	4	5	6	7
No. 8 120° 3-way joint		6	6	6	6	6

4m - series ★★★★★ Professional Prime

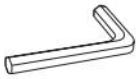
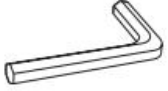
No. 9 120° 3-way joint		3	6	9	12	15
No.10 120° 3-way joint		4	4	4	4	4
No. 11 120° 3-way joint		2	4	6	8	10
No. 12 120° 3-way joint		2	2	2	2	2
No.13 Leg peg 6x180mm		6	8	10	12	14
No.14 Thin peg 4x180mm		22	28	34	40	46
No.15 Long bungee		106	128	150	172	194
No.16 Short bungee		18	18	18	18	18
No.17 Guy line 3m		4	4	4	4	4
No.18 M8x50mm Bolt with Wing nut		28	38	48	58	68
No.19 M8x70mm Bolt with Wing nut		26	34	42	50	58
No.20 M6x45mm Bolt with Wing nut		4	4	4	4	4
No.21 M6x60mm Bolt with Wing nut		4	4	4	4	4
No.22 Hook.		6	8	10	12	14

4m - series ★★★★★ Professional Prime

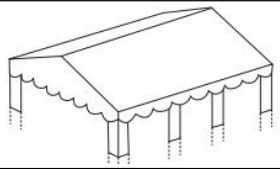
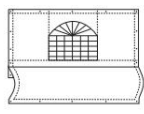
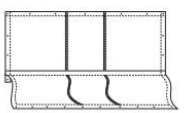
No.23 Allen Key M6		1	1	1	1	1
No.23-1 Allen Key M8		1	1	1	1	1
No.24 Wire rope		8	12	16	20	24
No.25 Turn-buckle		4	6	8	10	12
No.26 Clamp with 30mm bolt		6	8	10	12	14
No.27 Tube peg		4	4	4	4	4
No.28 Roof		1	1	1	1	1
No.29 Side wall		4	6	8	10	12
No.30 End wall		2	2	2	2	2



U K T E N T S . C O M