

5m - series ★★★★★PROFESSIONAL – 2,6m

Party Tent

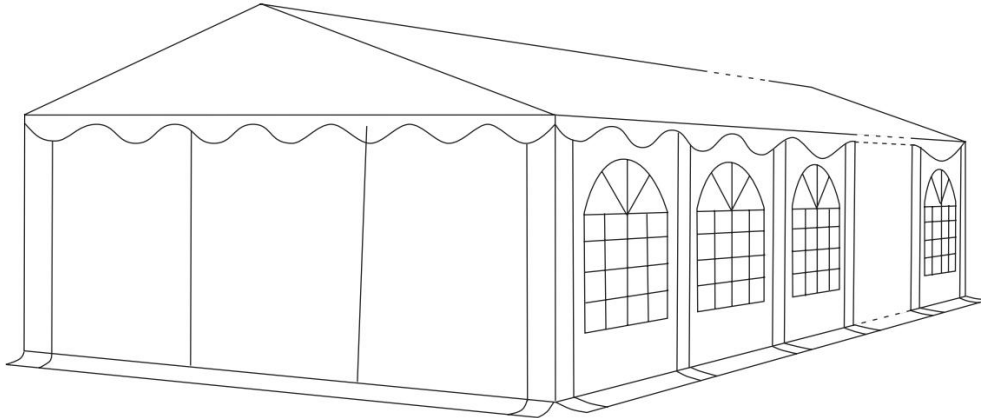

This high-quality tent is flame retardant and therefore can be used for public events. PVC cover according:



Please read instructions COMPLETELY before assembly. This tent MUST be securely anchored.

This tent is a temporary structure and should be disassembled at harsh weather conditions as stormy winds, snowfall or ice.

Warnings

Prior to installation, consult with all local municipal codes regarding installation of temporary shelters. The owner of the tent has the sole responsibility to make sure that these local rules are followed and that the mounting is correct.

We are not responsible for damage to the unit or the contents from acts of nature.

It is always recommended that you secure your tent properly with storm straps and ground pegs when you put up the structure. Proper Anchoring system selection is your responsibility. Heavy duty Anchor

5m - series ★★★★★PROFESSIONAL – 2,6m

are sold separately and are not included in this product.

Periodically check the anchors to ensure stability of shelter.

In case of extreme weather conditions, the tent cover must be removed.

Any shelter that is not anchored securely has the potential to fly away causing damage. We are not responsible for any shelter that blows away.

This canopy is intended to protect against the effects of sun, rain, light snow, etc. It is not designed to hold the loads that can accompany wind, rain, snow or ice storms. This structure is not tested for specific snow, rain and wind loads.

Do not use open fire, welding equipment or other ignition sources in the tent.

Cleaning and Storage

A tight cover ensures longer life and performance. Always maintain a tight cover. Loose fabric can accelerate deterioration of cover fabric.

Immediately remove any accumulated water, snow or ice from the roof structure.

DO NOT use bleach or harsh abrasive products to clean the fabric cover. Cover is easily cleaned with mild soap and water.

Safety Instructions

Please use gloves and stable shoes when assembling the metal frame portion of this unit. The metal components may have sharp edges and be oily cause of the metal processing.

Snow must be removed from the tarpaulin in a timely manner. Temporary accommodation as tents should be taken down in adverse weather condition like heavy wind, snowfall and ice.

Ensure sufficient distance of the tarpaulin to heat sources, electrical-, gas- and other pipes (min. 1.2m). You can obtain detailed information from your responsible authority.

Pay attention to the following points when choosing a location:

The pavilion must stand on a flat, non-slip and safe place

choose a sheltered location

Avoid damage to the material, please place the pavilion so that it cannot rub or chafe on branches, parts of buildings etc.

Put up the pavilion at a safe distance to fireplaces and pay attention to the direction of the wind

Leave your pavilion to dry in an erected position before packing it away.

Assembly Instructions

Step 1. Assembly is easiest if you layout all parts on the ground as shown below. 5x6m has 3 sections, 5x8m 4 sections, 5x10m has 5 sections, 5x12 has 6 sections and a 5x14m has 7 sections.

Assemble the roof frame by mounting parts 9 to 15 on the pipes (parts 1, 2, and 3).

Use the bolts 22 and 23 to attach the parts.

Note: No.9 at left corner, No.10 at right corner.

5m - series ★★★★★PROFESSIONAL – 2,6m

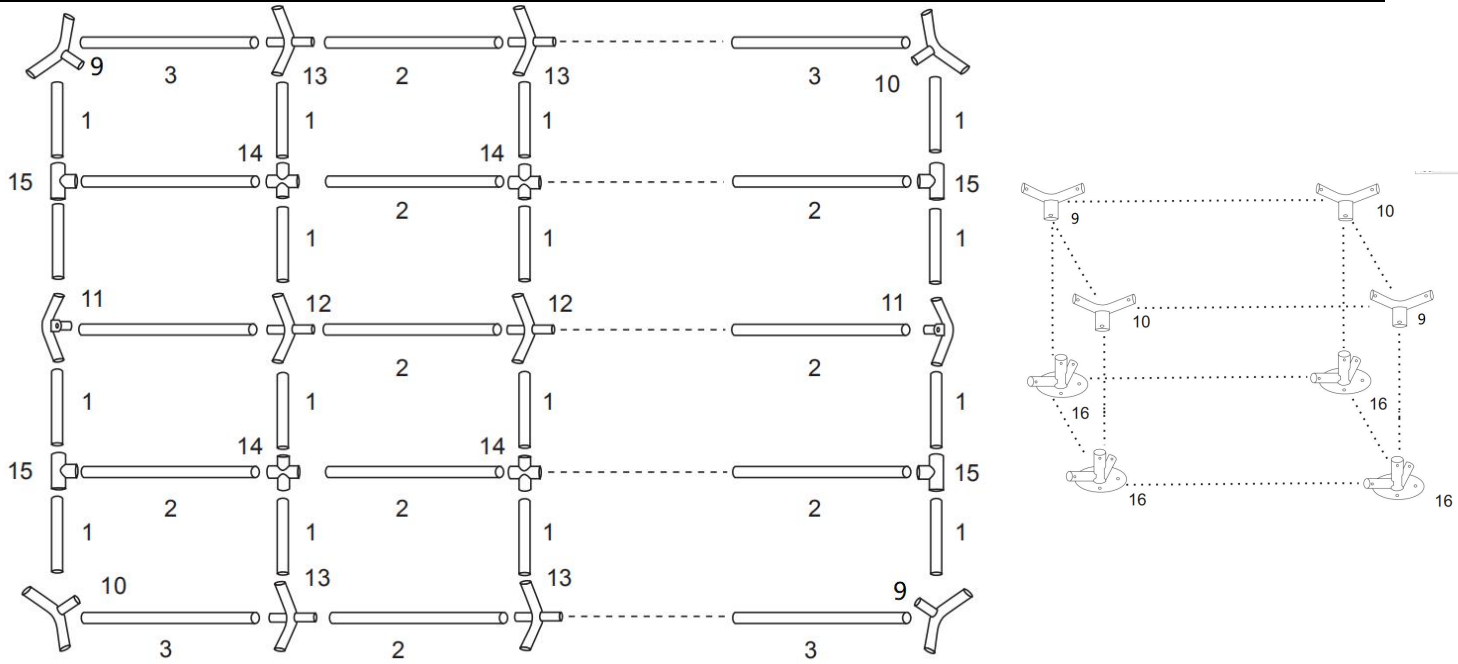

Step 2. Connect the roof poles and connectors from middle and out. Attach the reinforcement braces (parts 4 and 5) using bolts (24) and wing nuts (27).

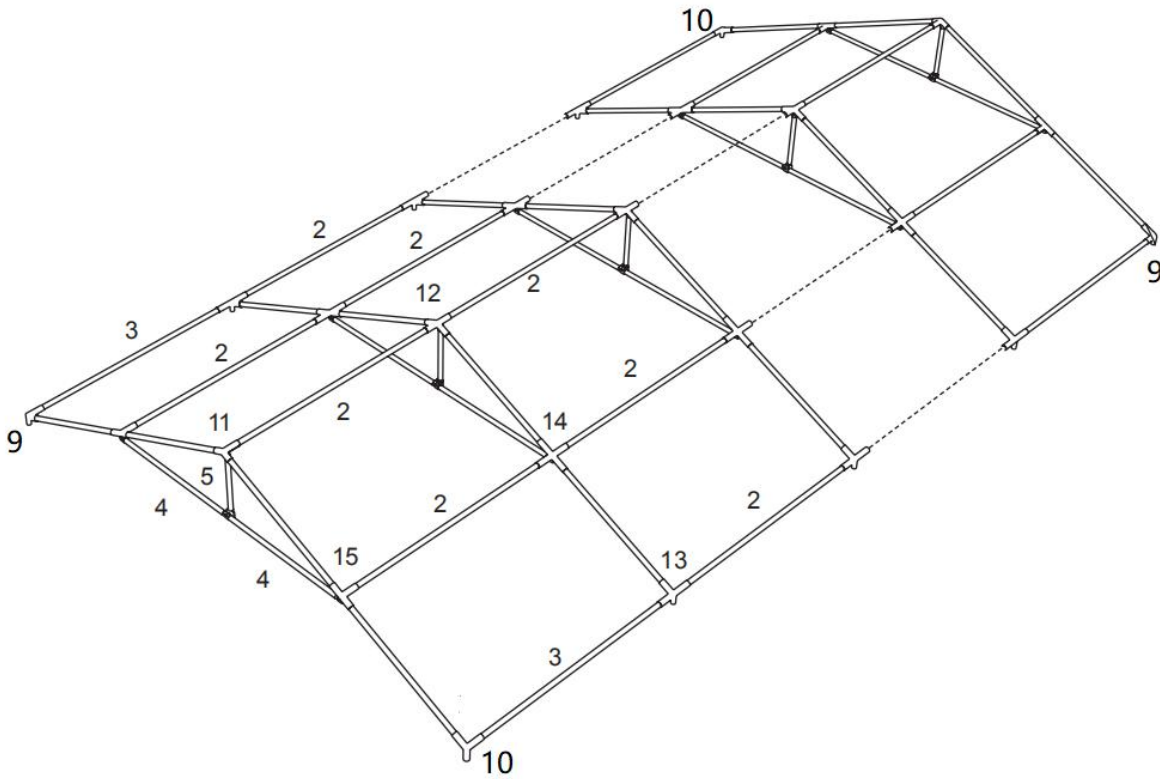

5m - series ★★★★★PROFESSIONAL – 2,6m

Step 3: Lift one side of the tent frame and attach the legs (7 and 8). Place the roof (34) onto the frame.

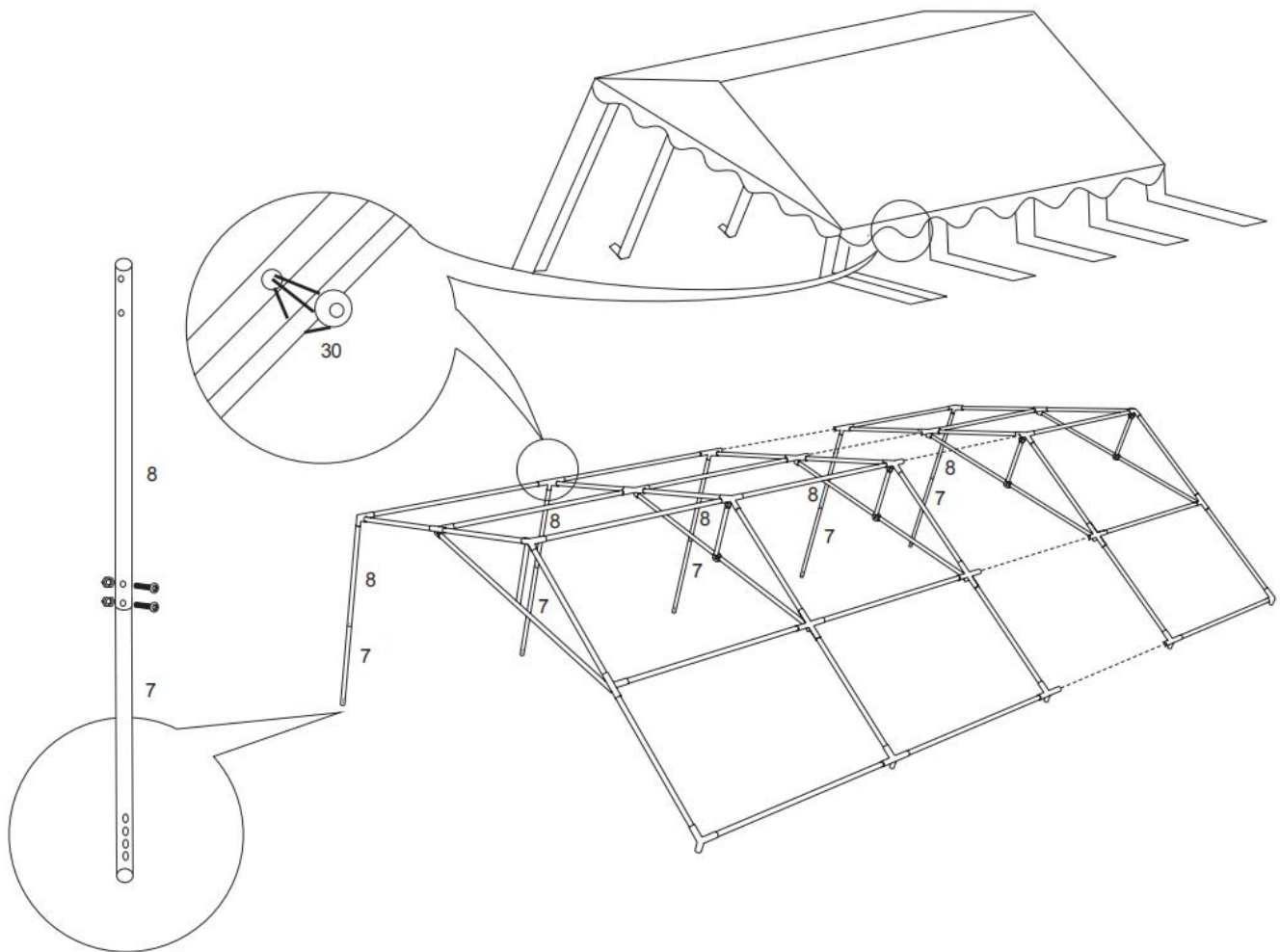

Step 4. Attach the legs on the other side and install the feet (16, 17) at the bottom. Make sure, that the leg pipes are in vertical position, to avoid overtention on the end walls. Attach the side covers to the pipes (7) using hooks (33). Reinforce the side frame by attaching the diagonal pipes (6) to all four corners. Complete the bottom frame with the required pipes (2a) and connector (18). Use the long ground pegs (19) to fasten the feet to the ground.

5m - series ★★★★★PROFESSIONAL – 2,6m

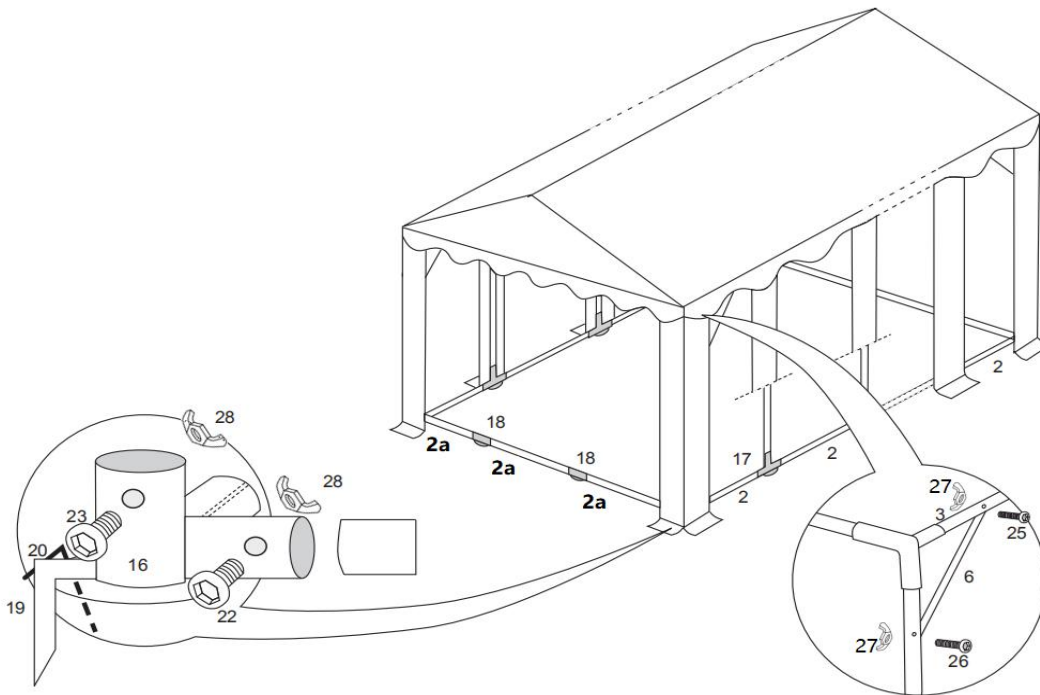



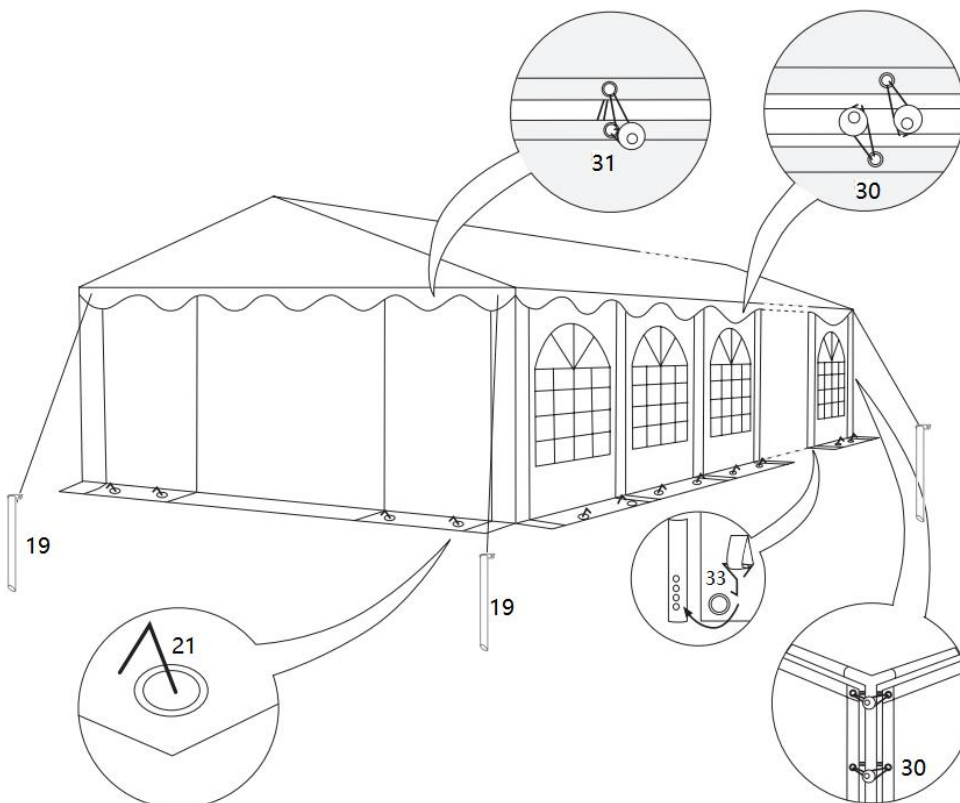



Step 5. Unfold the side walls (35) and the end walls (36) and attach the side walls to the frame using the bungees (30). Attach the end walls directly to the roof using the short bungees (31). Use the short ground pegs (21) to fasten the end walls to the ground. The guy rope(32) runs from every corner of the tent and is braced using the tube pegs (19).

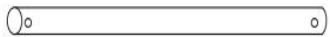



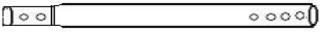
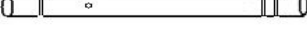
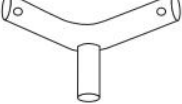
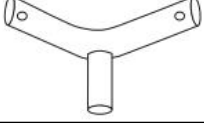
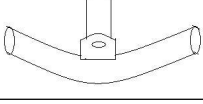
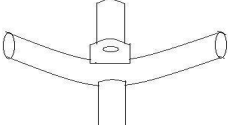

5m - series ★★★★★PROFESSIONAL – 2,6m



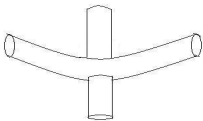
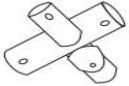
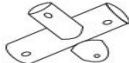

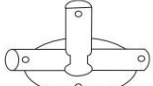
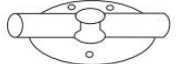
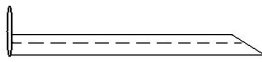
Parts List

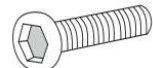
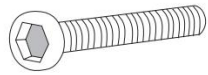
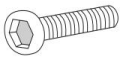
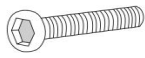
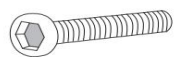
Part No.	Drawing	Quantity							
		5x6	5x8	5x10	5x12	5x14	5x16	5x18	5x20
No. 1 50x1430mm frame pole		16	20	24	28	32	36	40	44
No. 2 38x1920mm frame bar		17	24	31	38	45	52	59	66
No. 2a 38x1580mm frame bar		6	6	6	6	6	6	6	6
No. 3 38x1920mm frame pole		4	4	4	4	4	4	4	4
No. 4 25x1225mm roof brace		8	10	12	14	16	18	20	22
No. 5 25x440mm Roof brace		4	5	6	7	8	9	10	11
No. 6 25x1174mm diagonal brace		4	4	4	4	4	4	4	4
No. 7 50x1307mm pole		8	10	12	14	16	18	20	22
No. 8 50x1283mm pole		8	10	12	14	16	18	20	22
No. 9 110° 3-way joint		2	2	2	2	2	2	2	2
No. 10 110° 3-way joint		2	2	2	2	2	2	2	2
No. 11 140° 3-way joint		2	2	2	2	2	2	2	2
No. 12 140° 4-way joint		2	3	4	5	6	7	8	9

5m - series ★★★★★PROFESSIONAL – 2,6m

No. 13 110° 4-way joint		4	6	8	10	12	14	16	18
No. 14 cross 4-way joint		4	6	8	10	12	14	16	18
No. 15 "T" 3 way joint		4	4	4	4	4	4	4	4
No. 16 3-way joint		4	4	4	4	4	4	4	4
No. 17 3-way joint		4	6	8	10	12	14	16	18
No. 18 2-way joint		4	4	4	4	4	4	4	4
No. 19 Tube peg		8	10	12	14	16	18	20	22
No. 20 Long peg 8x300mm		8	10	12	14	16	18	20	22
No. 21 Short peg 4x180mm		28	34	40	46	52	58	64	70
No. 22 M8x50mm Bolt		54	68	82	96	110	124	138	152
No. 23 M8x70mm Bolt		56	82	98	114	130	146	162	178
No. 24 M6x30 Bolt		16	20	24	28	32	36	40	44
No. 25 M6x45 Bolt		4	4	4	4	4	4	4	4
No. 26 M6x60 Bolt		4	4	4	4	4	4	4	4

5m - series ★★★★★PROFESSIONAL – 2,6m

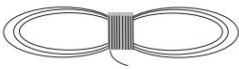
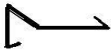
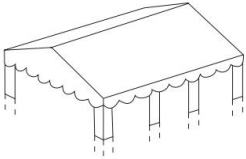
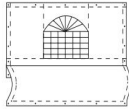
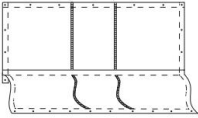
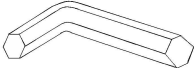
No. 27 M6 Wing nut		24	28	32	36	40	44	48	52
No. 28 M8 Wing nut		130	150	180	210	240	270	300	330
No. 29 Allen Key M8		2	2	2	2	2	2	2	2
No. 30 Long bungee		132	154	176	198	220	242	264	286
No. 31 Short bungee		22	22	22	22	22	22	22	22
No. 32 Guy rope 5m		4	4	4	4	4	4	4	4
No. 33 Hook		8	10	12	14	16	18	20	22
No. 34 Roof		1	1	1	1	1	1	1	1
No.35 Side wall		6	8	10	12	14	16	18	20
No. 36 End wall		2	2	2	2	2	2	2	2
No. 37 Allen Key M6		1	1	1	1	1	1	1	1



U K T E N T S . C O M