

# 5m - series ★★★★★PREMIUM Prime – 2,0m

## Party Tent

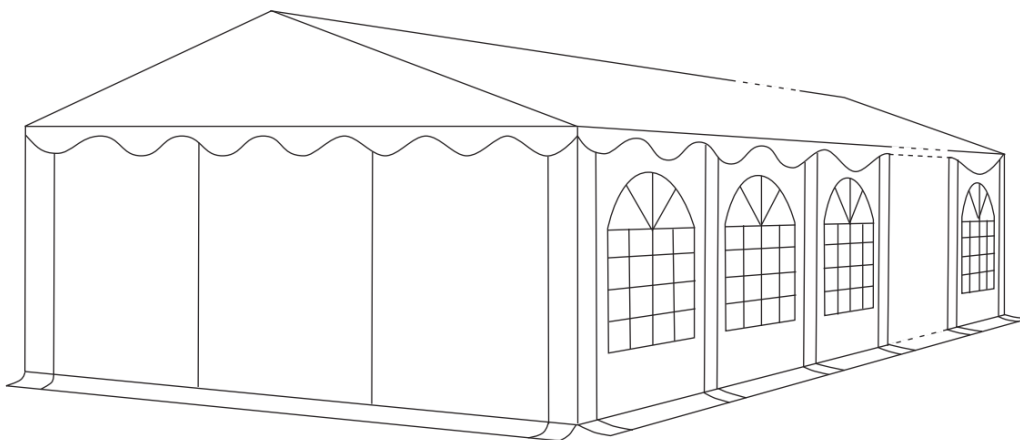

Please read instructions COMPLETELY before assembly. This tent MUST be securely anchored.

This tent is a temporary structure and should be disassembled at harsh weather conditions as stormy winds, snowfall or ice.

### Warnings

Prior to installation, consult with all local municipal codes regarding installation of temporary shelters. The owner of the tent has the sole responsibility to make sure that these local rules are followed and that the mounting is correct.

We are not responsible for damage to the unit or the contents from acts of nature.

It is always recommended that you secure your tent properly with storm straps and ground pegs when you put up the structure. Proper Anchoring system selection is your responsibility. Heavy duty Anchor are sold separately and are not included in this product.

Periodically check the anchors to ensure stability of shelter.

In case of extreme weather conditions, the tent cover must be removed.

Any shelter that is not anchored securely has the potential to fly away causing damage. We are not responsible for any shelter that blows away.

This canopy is intended to protect against the effects of sun, rain, light snow, etc. It is not designed to hold the loads that can accompany wind, rain, snow or ice storms. This structure is not tested for specific snow, rain and wind loads.

Do not use open fire, welding equipment or other ignition sources in the tent.

### Cleaning and Storage

A tight cover ensures longer life and performance. Always maintain a tight cover. Loose fabric can accelerate deterioration of cover fabric.

Immediately remove any accumulated water, snow or ice from the roof structure.

DO NOT use bleach or harsh abrasive products to clean the fabric cover. Cover is easily cleaned with

# 5m - series ★★★★★PREMIUM Prime – 2,0m

mild soap and water.

## Safety Instructions

Please use gloves and stable shoes when assembling the metal frame portion of this unit. The metal components may have sharp edges and be oily cause of the metal processing.

Snow must be removed from the tarpaulin in a timely manner. Temporary accommodation as tents should be taken down in adverse weather condition like heavy wind, snowfall and ice.

Ensure sufficient distance of the tarpaulin to heat sources, electrical-, gas- and other pipes (min. 1.2m). You can obtain detailed information from your responsible authority.

Pay attention to the following points when choosing a location:

The pavilion must stand on a flat, non-slip and safe place

choose a sheltered location

Avoid damage to the material, please place the pavilion so that it cannot rub or chafe on branches, parts of buildings etc.

Put up the pavilion at a safe distance to fireplaces and pay attention to the direction of the wind

Leave your pavilion to dry in an erected position before packing it away.

## Assembly Instructions

**Step1.** Assembly is easiest if you layout all parts on the ground as shown below. 5x5m has 2 sections, 5x7.5m 3 sections, 5x10m has 4 sections, 5x12.5 has 5 sections.

Assemble the roof frame by mounting parts 6 to 11 on the pipes (parts 1, 2 and 2b). Use the bolts

(18) and wing nuts (20) to attach the parts.

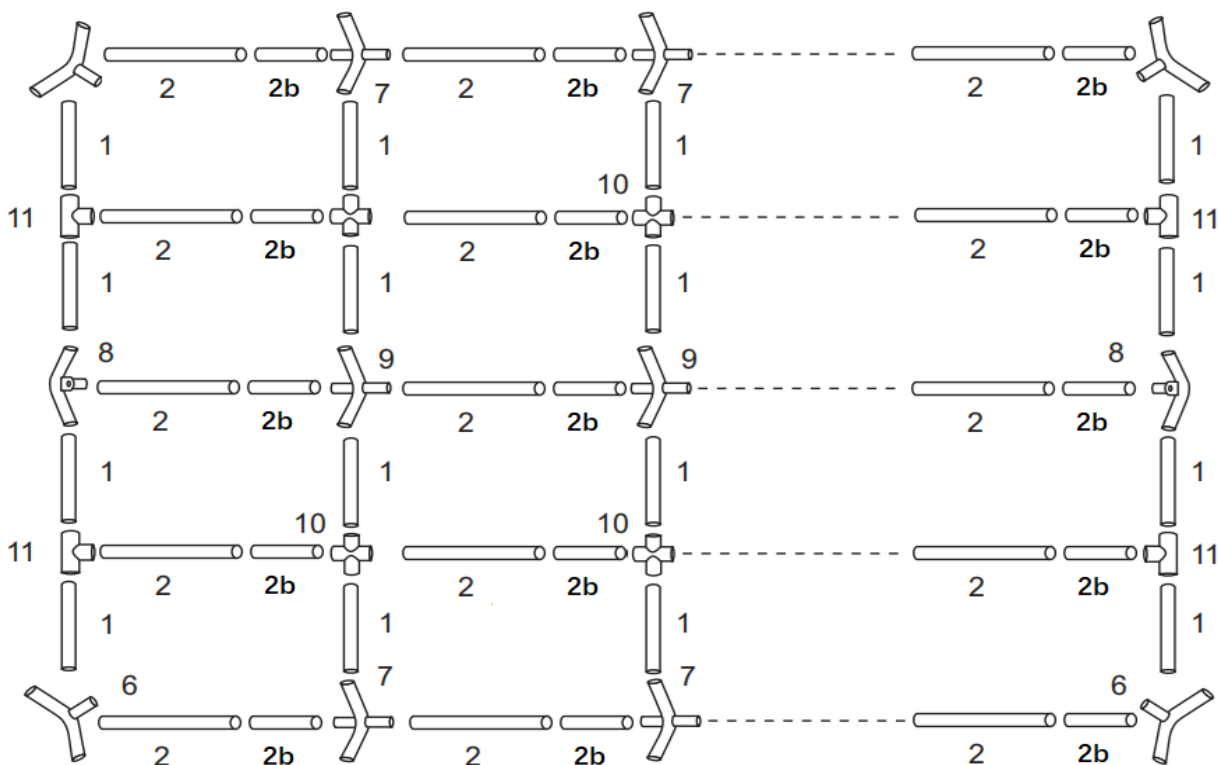

## 5m - series ★★★★★PREMIUM Prime – 2,0m

**Step 2.** Attach the reinforcement braces (parts 4 and 5) using bolts (19) and wing nuts (20).

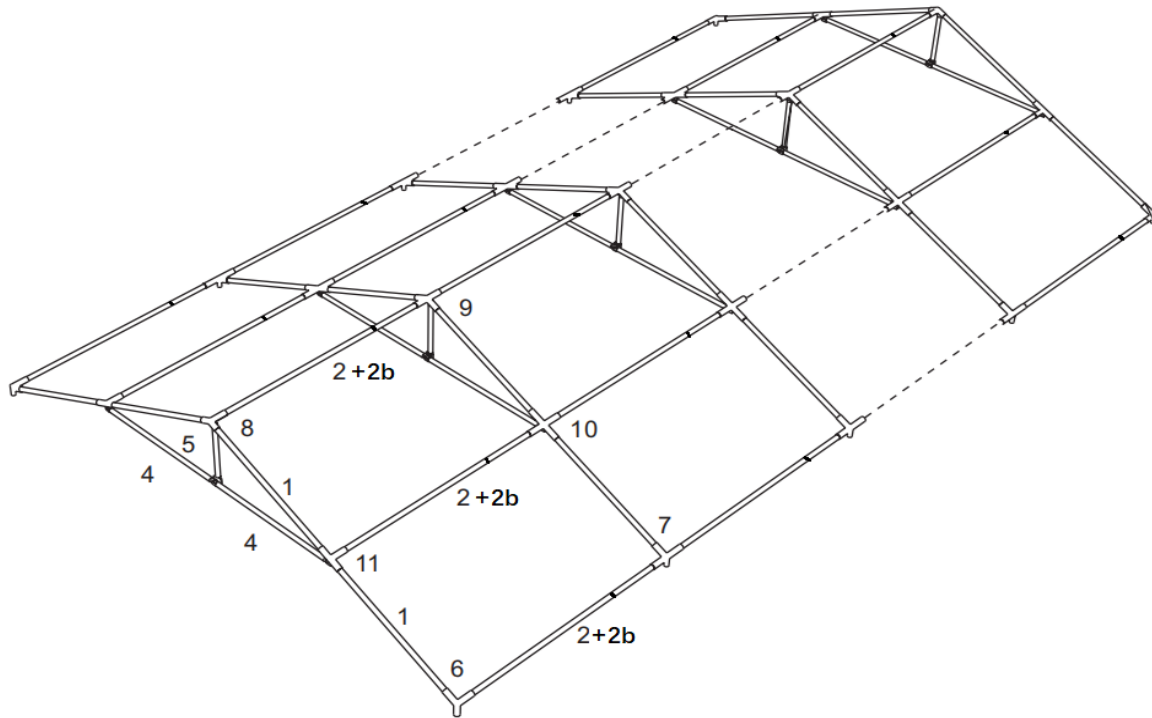

**Step 3.** Lift one side of the tent frame and attach the legs (3). Place the roof (26) onto the frame and use the bungees (22) to fasten it. Be sure not to put too much tension on the bungees in order not to make attaching the other side more difficult.

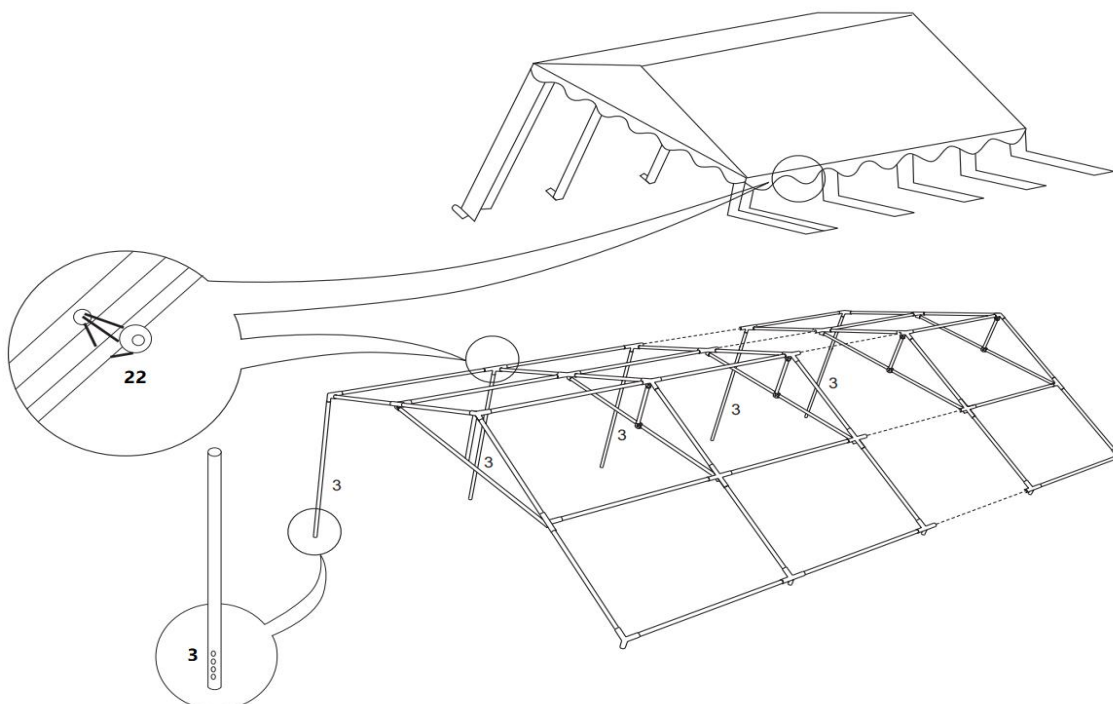

## 5m - series ★★★★★PREMIUM Prime – 2,0m

**Step 4.** Attach the legs on the other side and install the feet (12, 13) at the bottom. Make sure, that the leg pipes are in vertical position, to avoid overtention on the end walls. Attach the side covers to the pipes (3) using hooks (25). Complete the bottom frame with the required pipes (2a) and connector (14). Use the long ground pegs (16) to fasten the legs to the ground.

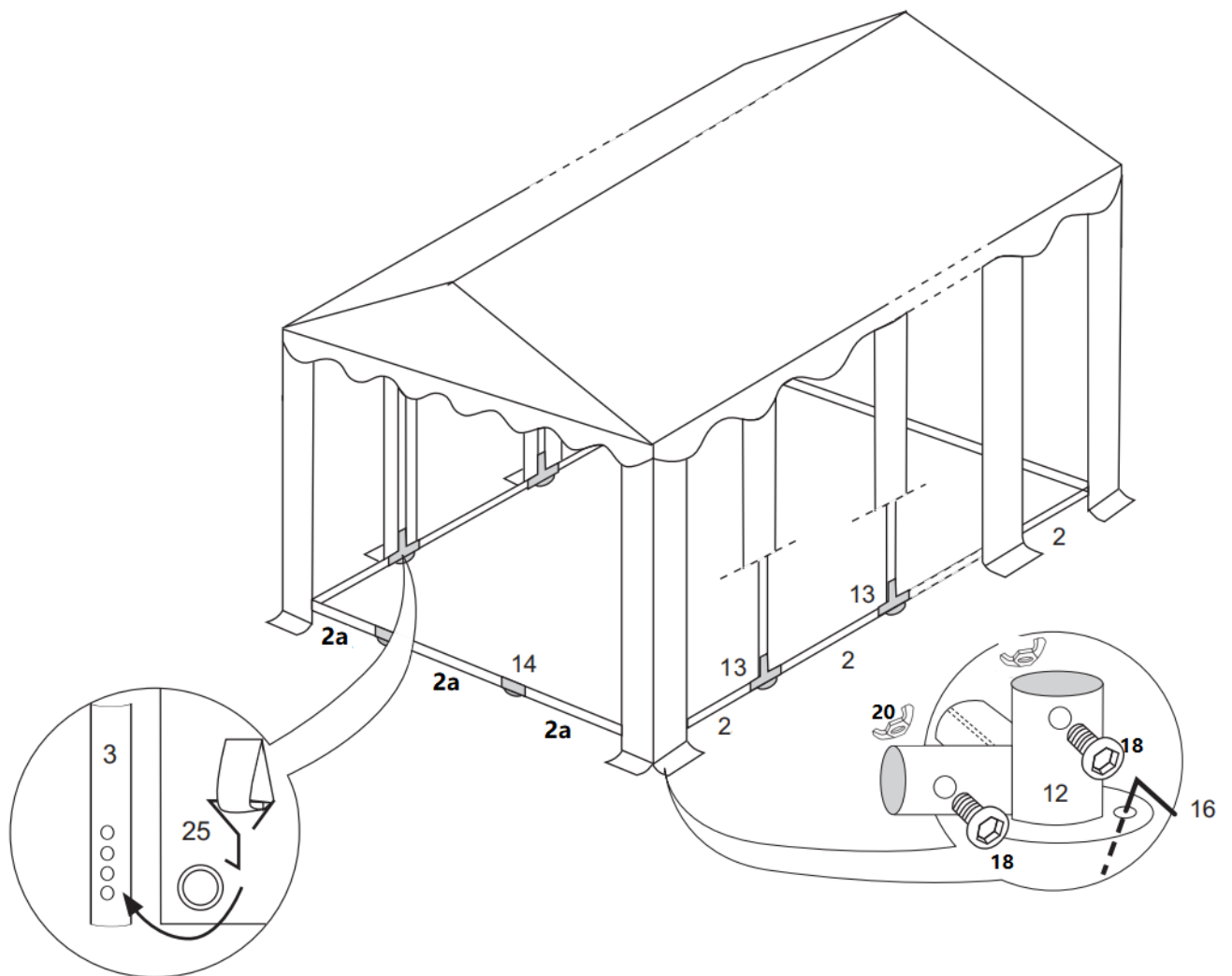





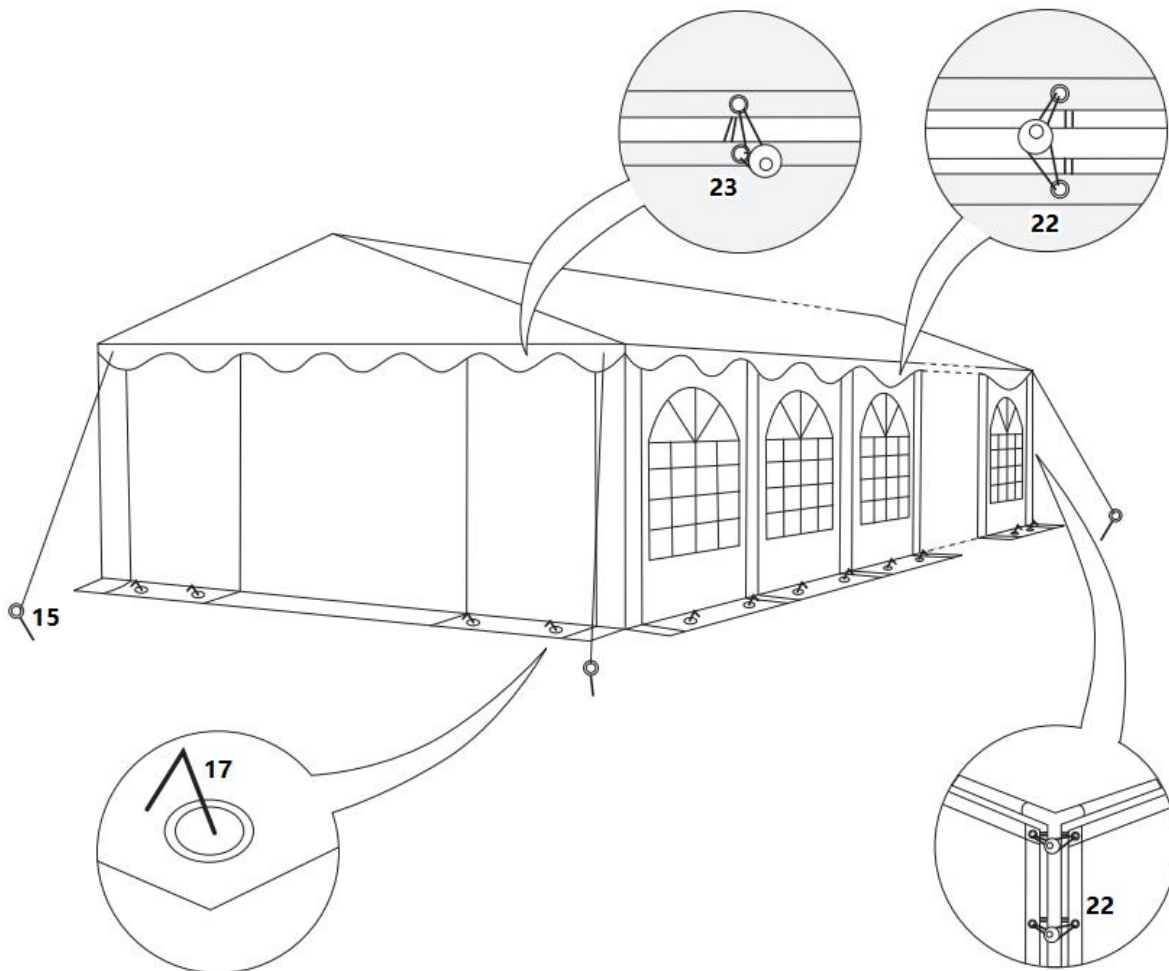

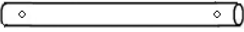

## 5m - series ★★★★★PREMIUM Prime – 2,0m

**Step 5.** Unfold the side walls (27) and the end walls (28) and attach the side walls to the frame using the bungees (22). Attach the end walls directly to the roof using the short bungees (23). Use the short ground pegs (17) to fasten the end walls to the ground. The guy rope(24) runs from every corner of the tent and is braced using the screw hooks (15).

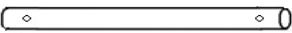
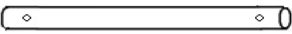
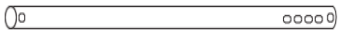
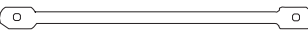
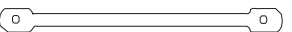

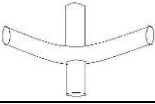

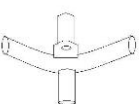
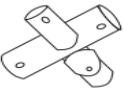
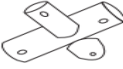

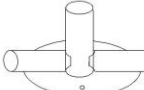



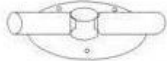

# 5m - series ★★★★★PREMIUM Prime – 2,0m

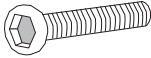
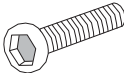
## Parts List

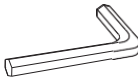
Item	Drawing	QUANTITY			
		5x5m	5x7.5m	5x10m	5x12.5m
(1) 1190mm frame pole		12	20	24	28
(2) 1930mm frame pole		14	21	28	35
(2a) 1590mm ground pole		6	6	6	6
(2b) 575mm frame pole		14	21	28	35
(3) 1895mm leg pole		6	8	10	12
(4) 1265mm brace		6	8	10	12
(5) 460mm brace		3	4	5	6
(6) <b>110°</b> 3 -way joint		4	4	4	4
(7) <b>110°</b> 4- way joint		2	4	6	8
(8) <b>140°</b> 3- way joint		2	2	2	2
(9) <b>140°</b> 4- way joint		1	2	3	4
(10) <b>Cross</b> 4-way joint		2	4	6	8
(11) <b>"T"</b> 3-way joint		4	4	4	4
(12) <b>3-way joint</b>		4	4	4	4
(13) <b>3- way joint</b>		2	4	6	8

## 5m - series ★★★★★PREMIUM Prime – 2,0m

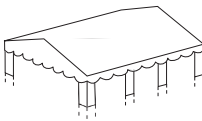
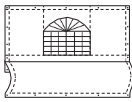
(14) 3- way joint		4	4	4	4
(15) Spiral Peg		4	4	4	4
(16)Thick Peg (6x180mm)		6	8	10	12
(17)Thin peg (4x180mm)		28	36	44	52
(18)50mm Bolt		90	121	152	183
(19)30mm Bolt		12	16	20	24
(20)Wing nut		102	137	172	207
(21) Spanner		1	1	1	1
(22) Long bungee		104	134	164	194
(23) Short bungee		22	22	22	22
(24) Guy rope 3m		4	4	4	4
(25) Hook		6	8	10	12
(26) Roof		1	1	1	1
(27) Side wall		4	6	8	10

5m - series ★★★★★PREMIUM Prime – 2,0m

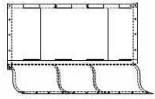
(28) End wall		2	2	2	2
---------------	---	---	---	---	---



U K T E N T S . C O M